

# Operating Instructions

## Melitta® Cafina® XT6

Melitta SystemService



## Content

<b>1. Description</b> .....	<b>3</b>	10.6 "Operation" menu item .....	17
<b>2. Intended Use</b> .....	<b>3</b>	a) Consumption and product statistics .....	17
<b>3. Technical data</b> .....	<b>3</b>	b) Machine settings .....	17
a) Unit data .....	3	c) Event display .....	17
b) Operating data .....	3	d) Exiting the Manager menu .....	17
c) Connections .....	3	<b>11. Cleaning</b> .....	<b>18</b>
d) Optional accessories .....	3	11.1 Cleaning intervals .....	18
<b>4. Accessories supplied</b> .....	<b>4</b>	a) Cleaning request .....	18
<b>5. Safety Instructions</b> .....	<b>4</b>	b) Automatic dispensing lock .....	18
<b>6. Installation</b> .....	<b>5</b>	11.2 Cleaning agents .....	18
6.1 Prerequisites .....	5	11.3 If you are working with canisters .....	18
a) Prerequisites for water connection .....	5	11.4 Daily cleaning.....	19
b) Prerequisites for electrical connection .....	5	a) Cleaning the grounds drawer .....	19
c) Requirements on the personnel .....	5	b) Start the cleaning programme .....	19
d) Requirements on the installation location .....	5	11.5 Cleaning the instant system .....	21
e) Requirements on the product material .....	5	a) Disassembling the mixer unit .....	21
6.2 Canister operation .....	5	b) Cleaning the mixer unit .....	21
<b>7. Chip keys</b> .....	<b>6</b>	c) Assembling the mixer unit .....	21
<b>8. Preparation</b> .....	<b>7</b>	11.6 Cleaning the coffee bean containers .....	22
8.1 Filling .....	7	11.7 Cleaning the instant coffee containers .....	22
a) Filling up the coffee provision .....	7	11.8 Clean touch screen .....	22
b) Filling up the instant powder .....	7	11.9 Cleaning the dispensing area .....	22
8.2 Switching On .....	8	<b>12. Preventive maintenance</b> .....	<b>23</b>
8.3 Switching Off .....	8	12.1 Intervals .....	23
8.4 Confirming filling levels .....	9	12.2 In case of defects .....	23
8.5 Emptying the grounds drawer .....	9	<b>13. Disposal</b> .....	<b>23</b>
<b>9. Dispensing products</b> .....	<b>10</b>	a) Waste disposal .....	23
9.1 Placing the vessel .....	10	b) Waste water disposal .....	23
9.2 Dispensing a product in Self-service operation ..	10	c) Disposal of cleaning agents .....	23
9.3 Dispensing a product in Waiter operation .....	10	d) Disposal of the machine .....	23
a) Cancelling dispensing a product .....	11		
b) Preset batch .....	11		
9.4 Dispensing products via product filters .....	12		
9.5 Manual coffee insertion .....	12		
<b>10. Settings</b> .....	<b>13</b>		
10.1 Calling up the Manager menu .....	13		
a) Making entries .....	13		
10.2 "Select" menu item .....	13		
a) Product groups .....	13		
b) Creating product groups .....	13		
c) Deleting product groups .....	14		
d) Editing product groups .....	14		
e) Adding products to be dispensed .....	14		
f) Deleting products to be dispensed .....	14		
g) Sorting products to be dispensed .....	14		
10.3 "Product filter" menu item .....	15		
a) Adding/deleting main criteria .....	15		
b) Editing the main criteria .....	15		
10.4 "Product" menu item .....	15		
a) Duplicating a product .....	16		
10.5 "Unit" menu item .....	16		
a) Changing filling levels to intermediate values .....	16		
b) "Maintenance" menu item .....	17		

### Translation of the original operating instructions

Please keep it near the machine, so that it is available for the operating personnel at any time should any questions arise.

Mach.No.: 10031401 [www.poetter-dokumentation.de](http://www.poetter-dokumentation.de)

Mat-Nr.: 26646 – Stand 03/2014

## 1. Description

This machine is an **automatic coffee machine** for dispensing coffee and coffee/milk products for **high daily consumption** in the catering industry.

Depending on the configuration of the machine, the following can be dispensed:

- Coffee and milk products,
- Instant products,
- Hot water and steam.

It is made from an aluminium housing and high-quality plastics. The design of the machine enables **compliance along with the operator duties** to satisfy the ...

- HACCP hygiene guidelines,
- Accident prevention regulations for electrical safety in commercial applications.

The machine is operated using a **touchscreen**.

## 2. Intended Use

This machine is **intended** ...

- for **operation** by instructed personnel,
- for unattended **self-service operation**,
- for fixed water connection,
- for **pressureless operation** using fresh water and waste water canisters,
- for **stationary** setup within dry, enclosed rooms.

This machine is **not intended** to be used ...

- in areas with **high relative humidity** (e.g. areas with heavy steam development) or outside,
- on board of **vehicles** or in mobile rooms (please consult the manufacturer).

**The type plate** is located behind the drawer (see 8.5).

## 3. Technical data

### a) Unit data

Dimensions (WxDxH).....:	300 x 580 x 715 mm
Weight.....:	54 kg
Coffee bean container.....:	1x / 2x 1000 g
Instant container.....:	1x / 2x 450 – 800 g
Grounds drawer capacity.....:	approx. 50 portions

### b) Operating data

Hourly capacity.....:	20-25 l Hot water
Permitted ambient temperature :	+5...30° C
Permitted relative humidity....:	< 80%

### c) Connections

Power supply.....:	see type plate
Power consumption.....:	2,8 kW max.
Fuse protection in building....:	16 A required
Connection.....:	Power cable 1.5 with grounded line plug
Freshwater connection.....:	min. 2.5 bar (250 kPa) (dynamic) at approx. 2 l/min.; if higher than 6 bar (600 kPa) a pressure reducer is required.
Carbonate hardness tap water:	1 - 3° dKH no action required, from 4° dKH decarboniser (Brita Purity) required, below 1° dKH consult manufacturer
Waste water connection.....:	mind. DN 25 - NW 1"
Noise level.....:	< 70 dB(A)

### d) Optional accessories

Cup warmer.....:	XT6 CW
Refrigerator.....:	XT6 MC18
Grounds discharge.....:	Container drop
Supply container.....:	Lockable coffee bean container

## 4. Accessories supplied

This machine is supplied with the following accessories:

- 2 green user chip keys
- 1 yellow manager chip key
- 1 cleaning container
- 1 extraction tool
- 1 microfibre cloth
- 1 Melitta® Cafina® Combi tablet
- 10 Melitta® Cafina® AMC cleaners
- 1 6-g coffee measuring scoop
- 1 operating instructions

## 5. Safety Instructions

These safety instructions refer only to the **machine** itself. Apart from that there may be legal obligations of the operator, e.g. concerning food hygiene as well as health and safety.

- ⚠ In the beverage dispensing area there is danger of **scalding** when hot liquids are dispensed. This is the case ...
  - ⚠ during **heating up** after switching on,
    - when **beverages are being dispensed**,
    - during automatic **cleaning**,
    - during the **flushing process** after switching off.
  - ⚠ **Danger of crushing** if somebody reaches into the provision container while the machine is operational.
  - ⚠ There may be **danger to life caused by electrical shock** as well as risk of injury due to hot or moving parts when housing parts or covers are opened.
    - Make sure that no person reaches into the machine while it is still switched on.
    - Never open any housing parts or covers unless instructed to do so. There are no operator elements inside the machine.
- ⚠ **Protect the machine from humidity!** There may be danger to life through electrical shock if water reaches machine parts other than those specifically intended for contact with water. You should ...
  - **never** operate the machine **outdoors**,
  - **never hose down** the machine **with water**,
  - **never** hose down the installation area with water, e.g. using a hose or high-pressure cleaner.

- ⚠ **Do not continue using the machine if damage is visible or apparent malfunction occurs.** Important safety functions may be disturbed in this case. It is recommended that the coffee machine is first inspected and, if necessary, repaired by the customer service. Examples are:
  - if the **housing** is damaged or covers do not close properly,
  - if the **power cord** or **power plug** are damaged or if the fuse for the circuit of the machine trips repeatedly,
  - if **water** escapes from the machine,
  - if **error messages** appear on the display or if the machine does not function normally,
  - if **unusual odours** can be detected or heat development on the housing is apparent (the housing is normally only warm to the touch during operation).
- **In all of these cases, remove the plug** from the power socket and turn off the water. Then notify customer service.
- ⚠ **Comply with all intervals** for cleaning, inspection and maintenance, as specified in the instruction manual. Otherwise, the safety, functional reliability and durability may be impaired.

## 6. Installation

Customer service will install and commission the coffee machine **ready for operation**. Due to the associated hazards, changes to the installation or setup of the coffee machine should only be completed by customer service.

### 6.1 Prerequisites

Make sure that the following prerequisites are met before you use the machine:

#### a) Prerequisites for water connection

The water connection must be easy to turn off at any time during operation (stop valve) and must meet the requirements of **EN 61770**.

As specified in the technical data, the values for water pressure and carbonate hardness must comply. The water supply must generally be equipped with a fine filter.

Only use the new **hose kit!** Old, previously used hose sets must not be connected.

The **waste water drain** must be installed as a fixed connection with odour trap, protected against backwater and backflow, in order to protect the machine against contamination from back flowing waste water.

#### b) Prerequisites for electrical connection

The **supply voltage** must match the specifications on the type plate.

The supply line must be **fuse-protected by the customer** using a **fault current circuit breaker (FCCB)** (max. 30 mA).

When connected via a **power plug**, the **outlet must be easily accessible** during operation to be able to disconnect the plug in case of malfunction. Due to the high load, a **single socket** is required for the machine and each accessory.

#### c) Requirements on the personnel

**Adjustments, cleaning and preparations** on the machine must only be performed by the installer or by persons instructed by customer service.

**Any repair and maintenance work** must only be performed by customer service or by professional personnel authorized by the manufacturer.

The machine must only be **operated (in the self-service or waiter operation)** by persons familiar with the general use of heat-generating appliances in the catering industry. Without supervision or appropriate instructions the machine must not be used by children or persons unable to safely use the unit be-

cause of their physical, sensory or mental abilities or their lack of experience or subject knowledge.

#### d) Requirements on the installation location

The machine must only be installed and used in closed dry rooms, it must not be operated **outdoors!** The effects of humidity and temperature may adversely affect the function and safety of the machine.

The machine may only be installed or stored at locations safe from **freezing**.

The installation area must offer a sufficient amount of **free space** – 10 cm at the back because of the heat development, 20 cm at the top to be able to fill the machine. For self-service operation the machine must be installed in such a way, that it can be **permanently monitored** by instructed personnel.

The machine must be in horizontal position and free of vibration. Adjustable **bases** are available for alignment on slightly uneven surfaces

#### e) Requirements on the product material

**Coffee beans** must be suitable for use in commercial coffee machines. Extraneous matter such as pieces of wood, stones or metal, etc should be removed to prevent damage to the grinding burrs.

**Coffee powder** or **instant powder** must be suitable for use in automatic coffee machines. Only use dry and loose, but no clumped material.

Use **ultra heat treated milk (UHT milk)** **cooled down** to approx. 4°C for the best possible quality cold milk foam.

### 6.2 Canister operation

If your machine is not permanently connected to the fresh and waste water system, you can also operate it with 2 canisters. **In this case also observe the limiting values for the water carbonate hardness.** The freshwater canister may need to be filled through the water filter (Brita).



- Plug the quick release coupling from ...
  - (1) the **supply** hose onto the connection on the fresh water canister,
  - (2) the **drain** hose onto the connection on the waste water canister.
- Always keep the connections clean and free of burrs to prevent the seal ring on the coupling from being damaged.
- You can loosen these connections again by simply sliding the ring on the **quick-plug coupling** back.

**Caution:** Canister operation requires the highest attention with regard to hygiene. Please observe the information under 11.3.

## 7. Chip keys

The machine is supplied with two **green user chip keys** and one **yellow manager chip key**.

The **green user** chip keys allow you to:

- switch the machine **on/off** (see 8.2),
- change the **filling levels** (see 8.4),
- carry out a **complete cleaning programme** on the machine (see chapter 11) and ...
- **clean the touchscreen** (see 11.8).

The **yellow manager** chip key provides you with the same options as the user chip key. **In addition to this**, the manager chip key also allows you to:

- make **settings** on the machine (see chapter 10),
- edit the **products to be dispensed** (see 10.2),
- create/edit **product groups** (see 10.2 a) and ...
- display **consumption and product statistics** (see 10.6 a).

Without a **chip key**, in **Waiter operation**, you can:

- **dispense preset products** (see chapter 9),
- dispense **steam**,
- switch the machine **off** (see 8.3),
- change the **filling levels** (see 8.4),
- carry out a **complete cleaning cycle** on the machine (see chapter 11) and ...
- **clean the touchscreen** (see 11.8).

**Without a chip key** in **Self-service operation**, you can only dispense preset products.

## 8. Preparation

Initial commissioning is carried out by customer service. If you wish to put the machine back into operation yourself after a period of inactivity ...

- carry out a cleaning programme as described in chapter 11.

### 8.1 Filling

- Check first if the **water tap** has been opened.
- (1) If your machine has a milk system, place the milk container into the milk cooler e.g. XT6 MC18 (optional milk cooler) and fill with cooled milk. Insert the **milk suction tube** into the milk.



#### a) Filling up the coffee provision

- Open the cover of the **coffee bean container**. If your machine is equipped with two bean containers, the ...
- (2) **Espresso beans** go in container 1 (front left) and ...
- (3) **Coffee beans** go in container 2 (back left).

#### b) Filling up the instant powder

**Note:** The instant coffee container must be inserted before the machine is switched on as otherwise no products can be dispensed.



**Caution:** The cover of the instant coffee container cannot be removed. Do not use force as this may damage the housing.

- (4) Open the cover of the **instant coffee container** with the key and ...
- lift it **upwards**.



- Fill all containers completely – but without compressing the powder.
- Then lower the cover back down and lock it with the key.

## 8.2 Switching On

- Open the **grounds waste door** as described under 8.5.
- The machine can be completely switched off (e.g. for long periods of inactivity) via the **main switch on the left**.

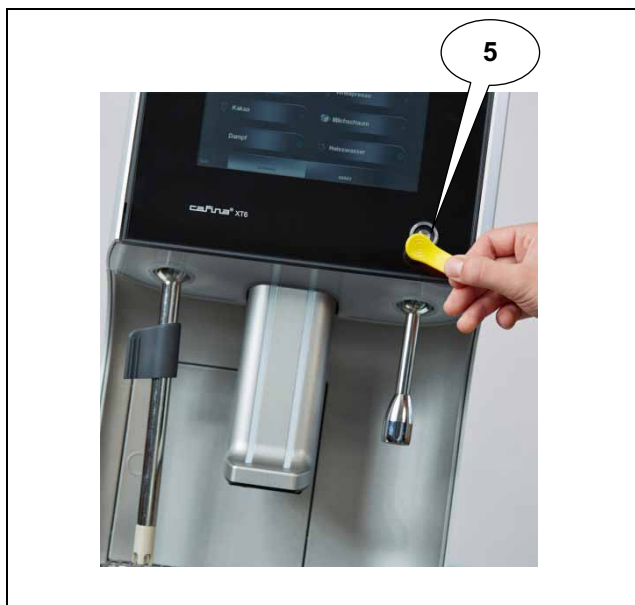

However, for every day operation it is sufficient to switch the machine on and off only by the **menu on the display**.

In preset **Waiter operation**, touch the display.



- (5) In preset **Self-service operation**, hold one of the **chip keys** in front of the **contact area** at the front of the machine so that it touches the contacts exactly.

The question **“Switch on unit?”** will appear on the display. Confirm this with **“Yes”**.

Once switched on, the machine will heat up and begin a components test. It takes a few minutes for the machine to be ready to dispense products.

The machine signals that it has heated up with a red LED next to the chip key contact area.

If a reminder to clean the machine appears after it has been switched on, carry out this process as described under 11.4.

## 8.3 Switching Off

**Note:** It is only possible to switch the machine off from **Self-service operation** using a **chip key**.

You can switch the machine off from **Waiter operation** by ...

- (6) touching the **“Unit”** button on the display and then ...
- (7) **“Clean and switch off full system”** if you wish to clean the machine before switching it off or ...
- (8) **“Switch off”** if you wish to switch the machine off immediately.

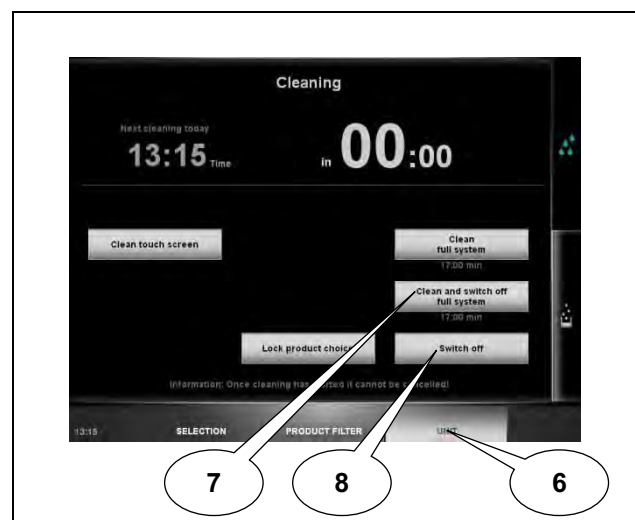



## 8.4 Confirming filling levels

Each complete filling of a provision container must be confirmed via the basic menu.

- If you have called up the **user interface** in Waiter operation, as described under 8.2 ...

- (1) select **“Unit”** and then ...
- (2) the **“filling level”** symbol.

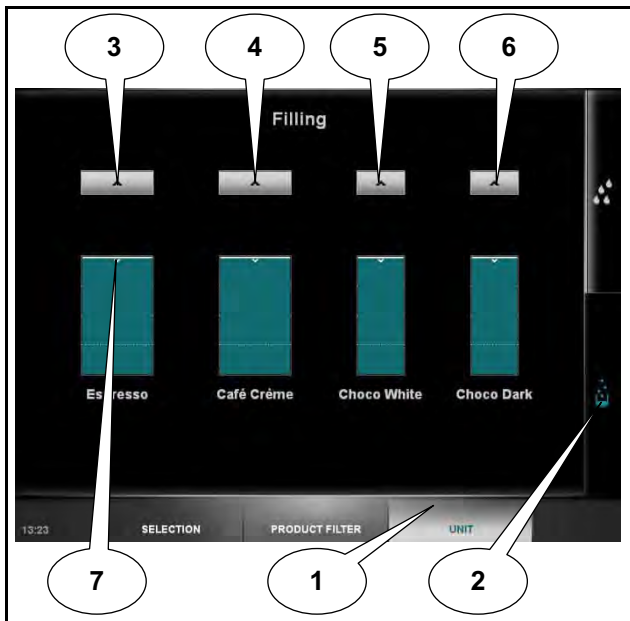

- Touch the button **above** the displays ...
  - (3) for **coffee bean container 1** (front left),
  - (4) for **coffee bean container 2** (bottom left),
  - (5) for the **left instant coffee container** or ...
  - (6) for the **right instant coffee container** to mark the container as **full** or ...
  - (7) set the exact filling level by **dragging** the relevant bar.

Always save your changes using the **“Save”** button. Otherwise, you will be asked whether you wish to discard the changes or go back to save the changes.

- You can **exit** these settings and return to the previous menu by ...
  - touching **“Select”** in **Waiter operation** or ...
  - **“Logout”** in the **Manager menu**.

## 8.5 Emptying the grounds drawer

*If the grounds are not discharged into the optional container, but into the grounds drawer:*

- Whenever you fill the bean containers, you should also empty the grounds drawer. The symbol **“Empty grounds drawer”** appears if the grounds drawer ...

- is **75%** filled, this is just enough for a few brewing processes,
- is **100%** full, only those products that do not produce any grounds can now be dispensed. All other products are greyed out and cannot be selected.



- Empty the **grounds drawer** into the normal household rubbish. To do this,
  - (8) swivel the **steam wand** (optional) **forwards** and ...
  - (9) push the **coffee outlet** right to the **top**.
  - (10) Then, press lightly on the **grounds waste door** until it springs open.

If the grounds drawer has been pulled out for more than 3 seconds, the display asks whether the grounds drawer has been **emptied** after it is reinserted.

- Respond by the **“Yes”** or **“No”** button.
  - The grounds drawer appears in the display as long as it is removed and has not been properly reinserted.

## 9. Dispensing products

As soon as the machine is heated up, the products that can be currently dispensed are shown in the display. If products are unavailable (because they have run out, for example) they are greyed out.

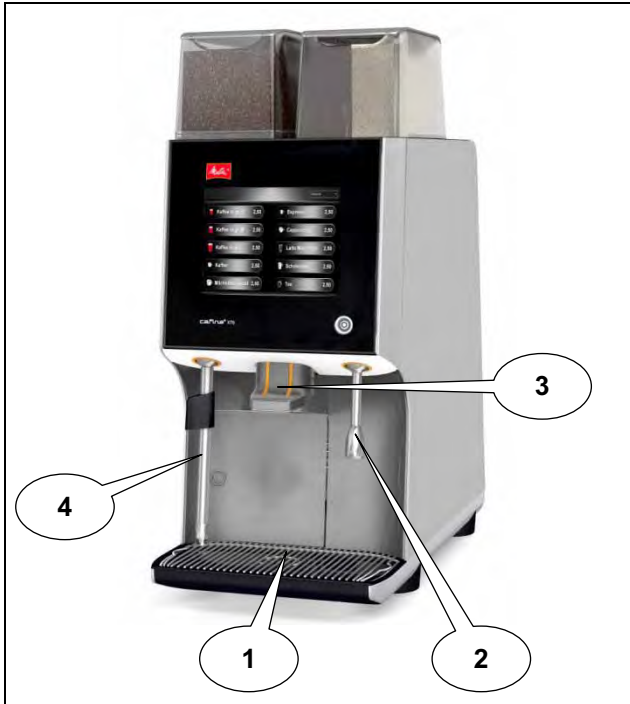

### 9.1 Placing the vessel

- You can place the individual cups centrally under the spout for **coffee/milk products**, or you can stand two cups next to each other.

**Note:** If a hot water wand has not been installed, **hot water** is also dispensed through the outlet for **coffee/milk products**.

- Place cups, pots or glasses on the **drip grill**.
- The **height** of the **coffee outlet** can be **adjusted** by pushing it.
- To dispense **hot water**, place the small and large containers on the drip grill under the **hot water wand** (optional).
- To dispense steam, hold the corresponding vessel for manual milk frothing, under the **steam wand**.

### 9.2 Dispensing a product in Self-service operation

To dispense a **coffee/milk product** or **hot water**, touch the product shown on the display.

- Select your preferred **display language** by touching the language selection field.



### 9.3 Dispensing a product in Waiter operation

To dispense a **coffee/milk product** or **hot water**, touch the product shown on the display.

- In Waiter operation, related products can be sorted into **groups**.

You can select **products to be dispensed** by touching the predefined group to open it, which then gives you access to the product you wish to dispense.

- Products to be dispensed** and **product groups** are identified using the following **symbols**:

- ☰: This is a **product group**. Open this by briefly touching the group.
- ▶: This **product** is dispensed by **touching the button once**. After dispensing, the machine returns to the start screen.
- : This **product** is dispensed **for as long as you touch** the button on the display. Once it has finished dispensing, return to the start screen by pressing the **“Overview”** button.
- You can **cancel a preselection** at any time by touching the **“Overview”** button. The machine then returns to the start screen.

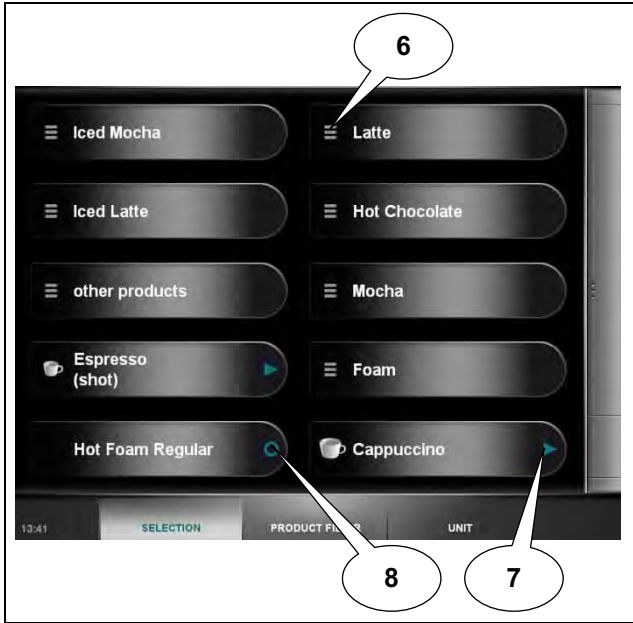

### a) Cancelling dispensing a product

(10) Depending on the product presetting, you can cancel the current dispensing of a product by touching the **cancel button "X"** while it is dispensing.

### b) Preset batch

With the preset batch, you can preselect multiple products and dispense them one after the other.

(11) Depending on the presetting in the **Manager menu** (10.6 b), the Batch order setting is switched on or off by default. To switch Preset batch on or off manually, touch the **Preset batch bar** on the right of the display.

- When Preset Batch is switched on, **touch** the selected products **one after the other**.

(12) Start dispensing the first product by touching the **start button "▶"**.

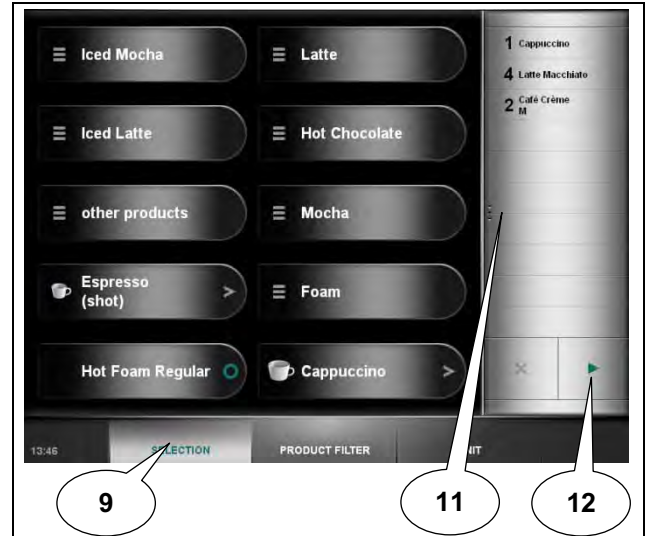
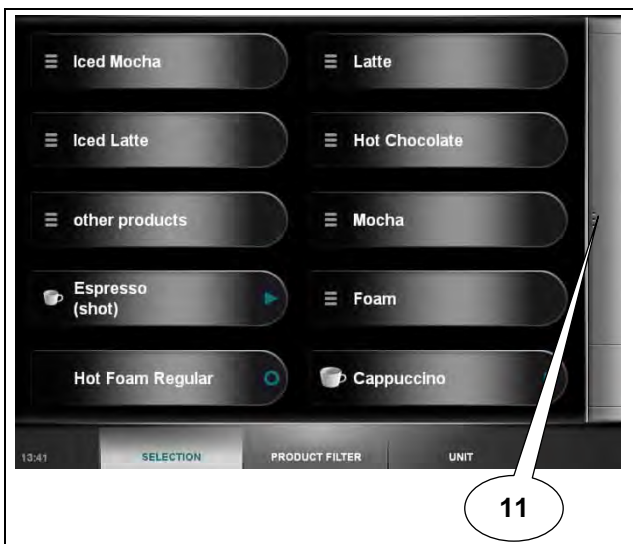

As soon as a product has been dispensed from the batch, remove it and place a suitable vessel for the next product under the appropriate nozzle.

(12) Touch the **"▶" button** to continue dispensing the product. Once all products from the batch have been dispensed, the machine returns to dispensing standby.



(13) To add or remove products from the batch while a product is being dispensed, touch **"Batch order"**.

Delete the products from the dispensing batch by selecting the product on the display and touch the **cancel button "X"** ...

- **briefly** to delete a product or ...
- **hold it down** to delete all products in a group.

## 9.4 Dispensing products via product filters

Dispensing a product via product filters involves selecting the desired product using various selection criteria.

You may choose from the following criteria:

- (13) **Size:** You can set the preselectable size of portion.
- (14) **Coffee:** You can set whether a product is to be preselected with/without coffee or with decaffeinated coffee.
- (15) **Milk:** You can set whether a product is to be preselected with/without milk.
- (16) **Syrup:** You can set whether a product is to be preselected with/without syrup.
- (17) **Milk temperature:** You can set whether a product is to be preselected with cold/warm milk.
- (18) **Milk consistency:** You can set whether a product is to be preselected with milk or milk foam.

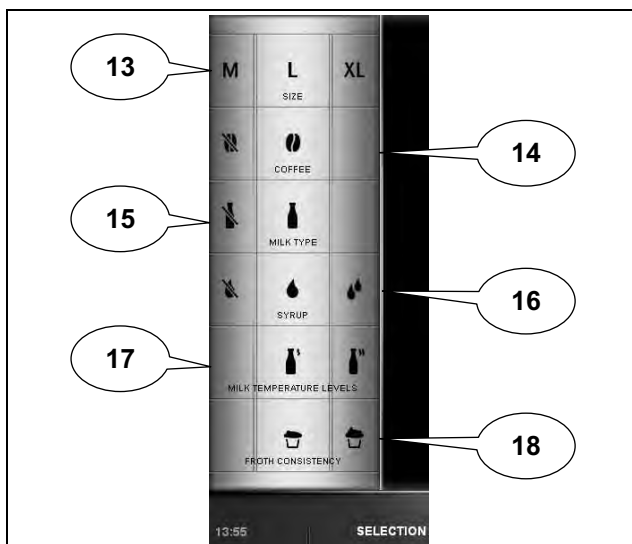

After you have set the product to be dispensed using the **preselected product criteria** ...

- **touch** the product on the display to **dispense** it.

## 9.5 Manual coffee insertion

You have the option to insert coffee powder (e.g. decaffeinated coffee) into the machine yourself. If you select this option, the machine does not take beans from the coffee bean containers, but waits for coffee powder to be inserted with the measuring spoon.

**Select** a preprogrammed product with manual coffee insertion to be dispensed.

As soon as the machine prompts you to insert the coffee powder, place a heaped spoon (approx. 8-9 g)

of coffee powder in the chute and ...



(19) confirm this on the display.

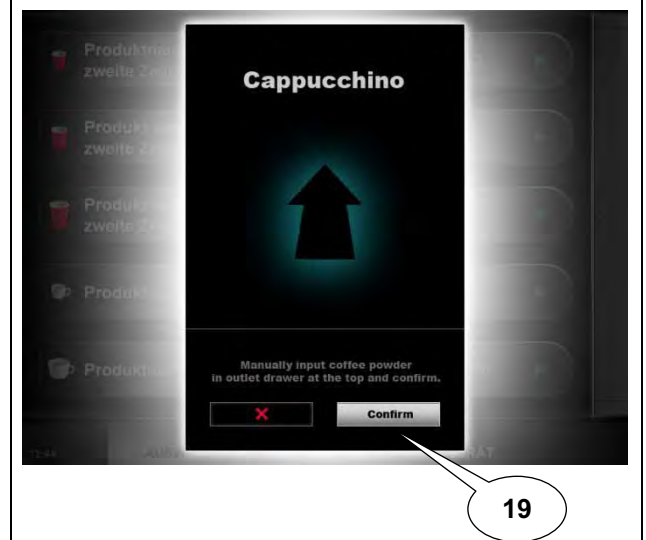
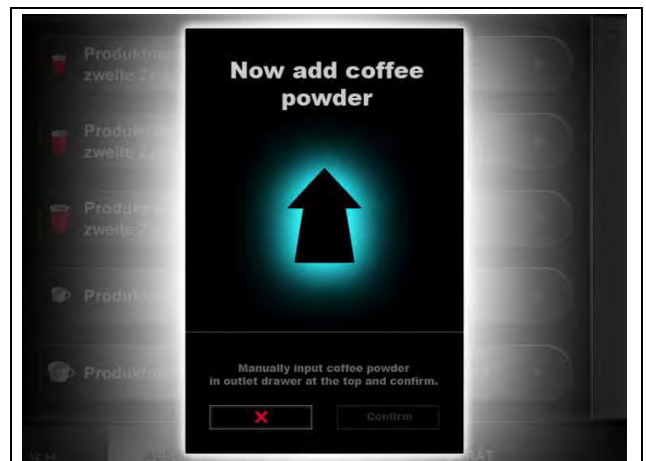

Make sure you do not insert too much coffee powder in the chute as if you do the machine will interrupt the process with an error message and eject the coffee powder into the grounds drawer.

## 10. Settings

The machine is preset so that it can be used immediately in the normal operating mode. The functions described here can only be accessed if they have been enabled by customer service.

### 10.1 Calling up the Manager menu

- Hold the **Manager chip key** just in front of the contact area at the front of the machine so that it touches the contacts exactly.
  - The **Manager menu** appears on the display.
- Exit the menu by touching **“Logout”**.

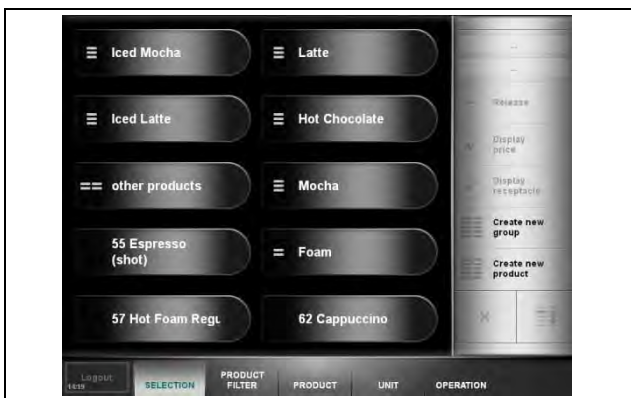

The Manager menu allows you access to various machine setting options. Touch ...

- **“Select”** to release products for dispensing, create product groups or for administration (see 10.2),
- **“Product filter”** to edit selection criteria for the product filter in the Waiter menu (see 10.3),
- **“Product”** to edit products to be dispensed (see 10.4),
- **“Unit”** to clean or switch off the machine and to change the filling levels (see 10.5),
- **“Operation”** to make settings on the machine or display the dispensing statistics and important events (see 10.6).

#### a) Making entries

The machine allows you to enter names and quantities using the **on-screen keyboard**.

When the on-screen keyboard appears on the display, you can ...

- (1) write using the **letter field/numeric keyboard**,
- (2) delete the characters you have entered using the **“←”** key,
- (3) **save** what you have entered using the **“Enter”** key,

- (4) toggle between upper and lower case using the **“Case”** key,
- (5) **cancel** what you have entered using the **“Cancel”** key.

Some keys are also assigned **special characters** (e.g. the “S” key).

Hold these keys down to access the special characters.

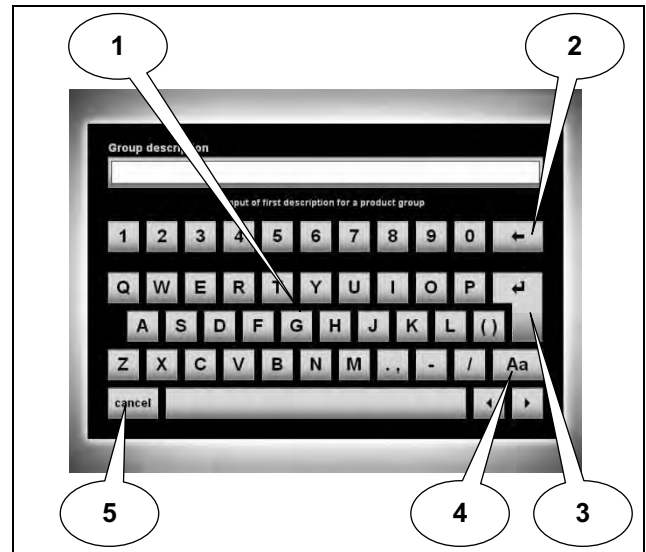

### 10.2 “Select” menu item

You can specify which preprogrammed products are to be displayed for dispensing or collect products together into product groups.

#### a) Product groups

You can collect related products into groups so that **more than 10 products** can be dispensed in order in **Waiter operation**.

#### b) Creating product groups

To create a **new product group** ...

- (6) touch the **“Create new group”** button on the display.
  - A new product field, **“Edit group”**, appears on the display.
  - You can choose any **name** you like for the product group by touching the group to select it and ...
- (7) touching the **“1st group description”** or **“2nd group description”** button.
  - Change the description using the on-screen keyboard, as described under 10.1 a).
- (8) Release the group you have created for dispensing by touching the **“Release”** button, as other-

wise it will not be displayed on the dispensing user interface.

### c) Deleting product groups

You can **delete** displayed **product groups**, including the products they contain for dispensing by touching the product group to select it and ...

(10) touching the “**X**” button.

- You are prompted to confirm the deletion. Touch ...
  - “**Cancel**” if you wish to cancel the deletion process or ...
  - “**Delete**” to confirm the deletion.

**Note:** Only the display on the screen is deleted. The products are still saved in the machine.

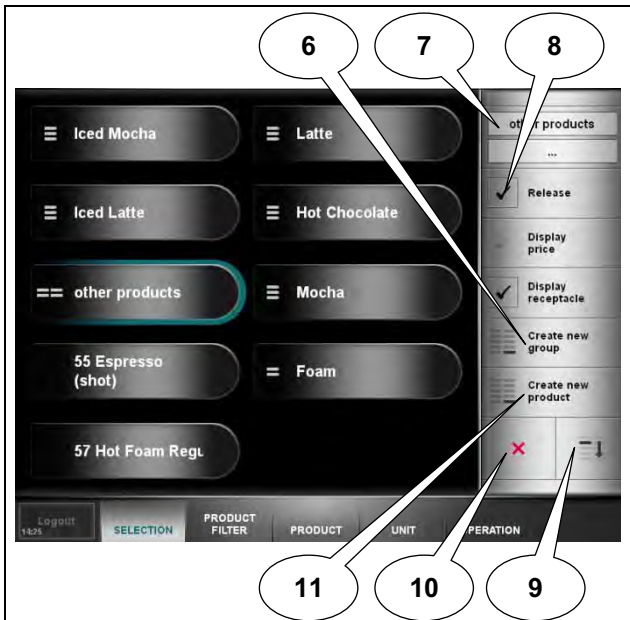

### d) Editing product groups

If you touch ...

- “**Release**”, you can release/block the selected group for dispensing.
- “**Display price**”, you can display/hide the price for the selected group in **Self-service operation**.
- “**Display receptacle**”, you can display/hide a symbol for the recommended dispensing receptacle for dispensing.

Always save your changes using the “**Save**” button. Otherwise, you will be asked whether you wish to discard the changes or go back to save the changes.

### e) Adding products to be dispensed

**Note:** If you have only entered one product to a product group, only this product will be displayed during dispensing and not the product group.

- Select the **product group** which you wish to add a product for dispensing to and ...
  - **open** it by pressing the symbol again.

(11) Touch “**Create new product**” on the display.

- A new product field, “**Select product**”, appears on the display. Touch this symbol to open the product list.
- Select the desired product to be dispensed by touching it.

(8) Release the product you have created for dispensing by touching the “**Release**” button, as otherwise it will not be displayed on the dispensing user interface.

### f) Deleting products to be dispensed

You can **delete** displayed products to be dispensed by touching the product to select it and ...

(10) touching the “**X**” button.

- You are prompted to confirm the deletion. Touch ...
  - “**Cancel**” if you wish to cancel the deletion process or ...
  - “**Delete**” to confirm the deletion.

**Note:** Only the display on the screen is deleted. The products are still saved in the machine.

### g) Sorting products to be dispensed

You can **sort** products to be dispensed however you like by touching the product to select it and ...

(9) moving products to be dispensed downward by pressing “**Down**”.

Always save your changes using the “**Save**” button. Otherwise, you will be asked whether you wish to discard the changes or go back to save the changes.

### 10.3 “Product filter” menu item

You can specify which selection criteria should be available for filtering products to be dispensed in **Waiter operation**.

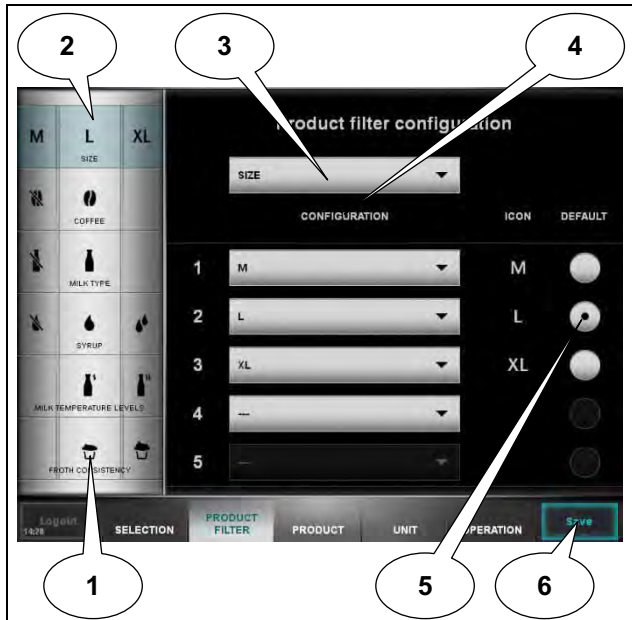

The following main criteria can be preset:

- **Size:** You can set the preselectable size of portion.
- **Coffee:** You can set whether a product is to be preselected with/without coffee or with decaffeinated coffee.
- **Type of milk:** You can set whether a product is to be preselected with/without milk, or what type of milk it is to be preselected with.
- **Heat milk:** You can set whether a product is to be preselected with warm or cold milk.
- **Preparation:** You can set whether a product is to be preselected with milk or milk foam.
- **Foam consistency:** You can set whether a product is to be preselected with normal foam or stiff foam.

#### a) Adding/deleting main criteria

If you wish to **add** a main criteria (e.g. size) to the selection ...

- (1) touch an **empty entry** and ...
- (3) **select** the criteria.

If all possible criteria have already been added, you cannot add any more criteria.

If you wish to **delete** a main criterion (e.g. coffee) from the selection ...

- (2) select the criterion **to be deleted** in the selection and ...
- (3) select the entry “---”.
- (6) Always save your changes using the **“Save” button**. Otherwise, you will be asked whether you wish to discard the changes or go back to save the changes.

#### b) Editing the main criteria

You can edit the main criteria by allocating various filters.

- (2) Select the **main criterion** which you wish to edit (e.g. coffee).
- (4) Under the **“Configuration”** menu item, select the **filter** which you wish to release for preselection in Waiter operation (e.g. no coffee, coffee, decaffeinated coffee).  
Select “---” to prevent this filter from being released in Waiter operation.
- (5) Set which filter should be **preselected** by default in Waiter operation (e.g. coffee).
- (6) Always save your changes using the **“Save” button**. Otherwise, you will be asked whether you wish to discard the changes or go back to save the changes.

### 10.4 “Product” menu item

You can change the product component values as long as this is permitted by customer service.

- Select the **“Products”** function to display a list of all products.
- Drag the list with the **▲ ▼ buttons** to display all programmed products.
- **Touch a product** to edit it.
- Switch between the different setting options using the **▲ ▼ buttons**.
- Select the **component** (e.g. coarseness of grounds) or **value** (e.g. price, item number) to be changed.
- You can now change the values for this product using the **on-screen keyboard**.

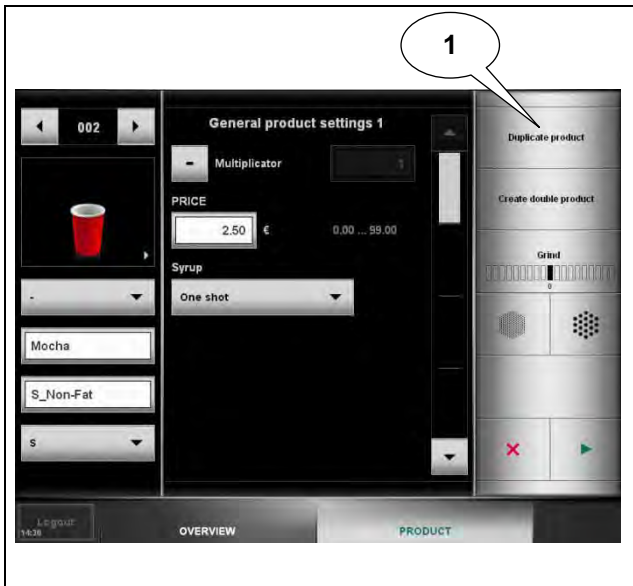

**Note:** Products which have a \* in their ID cannot be edited. These products are preprogrammed in the machine's basic settings.

Always save your changes using the **“Save”** button. Otherwise, you will be asked whether you wish to discard the changes or go back to save the changes.

#### a) Duplicating a product

To use an **existing product** as the base product for a new product, select the desired product from the product list and ...

- (1) touch **“Duplicate product”**.
  - The question **“Duplicate product?”** will appear on the display. Confirm this with **“Duplicate”**.

You can now **alter** the various **values** for the duplicated product. Proceed as described under 10.4.

Always save your changes using the **“Save”** button. Otherwise, you will be asked whether you wish to discard the changes or go back to save the changes.

### 10.5 “Unit” menu item

This menu item can be used to clean the machine and adjust the filling levels.

#### a) Changing filling levels to intermediate values

In addition to the option described under 8.4 for confirming the coffee bean containers as full, you can also set intermediate values for the filling levels:

- (2) Select the **“Filling”** function.
- (5) You can now use the **▲** button to change the filling level to **100%** or ...
- (4) set the exact filling level by **dragging** the bar.
- (3) You can change the **name** of the beans and the instant coffee container using the on-screen keyboard.

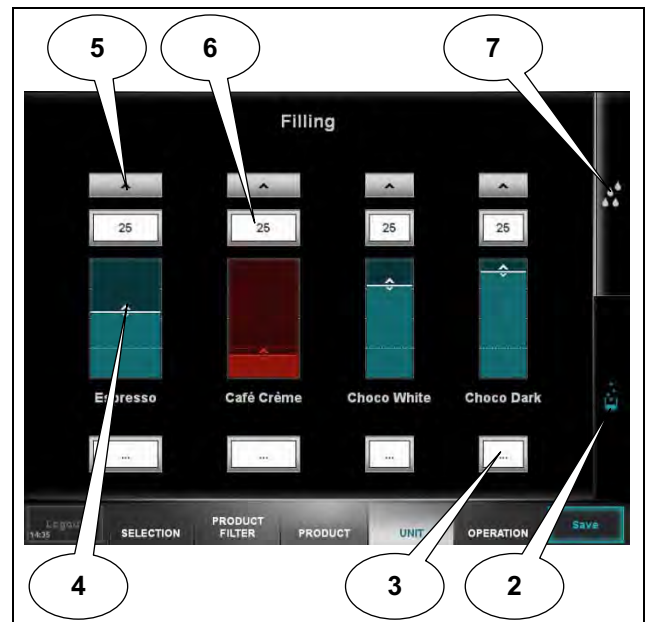

A warning is issued on the display as soon as the filling level of a consumable falls below a specified value.

- (6) Enter a percentage value for the filling level below which a warning should be issued.

Always save your changes using the **“Save”** button. Otherwise, you will be asked whether you wish to discard the changes or go back to save the changes.



## b) “Maintenance” menu item

This menu item can be used to clean the machine (see chapter 11), switch it off and see when the last cleaning programme was carried out, the time to the next clean and the time the next cleaning reminder will be displayed.

- (7) Select the “**Maintenance**” menu and touch ...
  - “**Clean full system**” if you wish to have the milk and brewing system cleaned and then continue to operate the machine.
  - “**Clean and switch off full system**” if you wish to have the milk and brewing system cleaned and then switch the machine off.
  - “**Switch off**” if you wish to switch the machine off.

## 10.6 “Operation” menu item

This menu item can be used to read the consumption and product statistics and make settings on the machine.

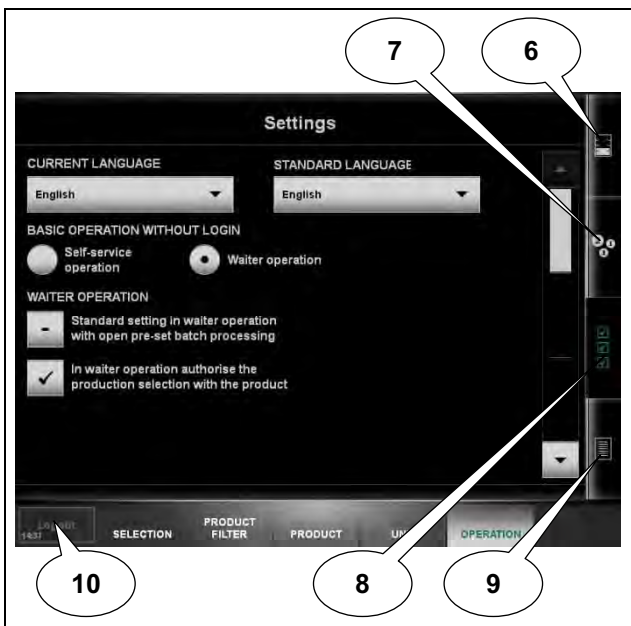

## a) Consumption and product statistics

- (6) Select the “**Consumption**” symbol to read statistics on the consumption of individual machine components (e.g. ground coffee level).
- (7) Select the “**Product counter**” symbol to read how often each product has been dispensed.
  - Drag the list with the ▲ ▼ buttons to display all programmed products.

## b) Machine settings

- (8) Select the “**Settings**” symbol to display and edit the machine's basic settings.
  - Drag the list with the ▲ ▼ buttons to display all setting options.
    - You may choose from the following settings:
      - “**Current language**”: You can set the current display language.
      - “**Default language**”: You can set the default language for the machine.
      - “**Basic operation without login**”: You can set the default operating mode for the machine. Choose between Self-service operation and Waiter operation (see chapter 9).
      - “**Waiter operation**”: You can set whether bulk processing is activated by default in Waiter operation (see 9.3 b) and whether the product filter should be available in Waiter operation.
      - “**Date**”: You can set the current date using the on-screen keyboard.
      - “**Time**”: You can set the current time using the on-screen keyboard.
      - “**Summertime**”: You have a choice between the settings “**Automatic**” and “**No**”.
      - “**Cleaning time**”: Select cleaning time “**1**” or “**2**” if you wish to set the times for automatic cleaning reminders on the display (see 11.1 a). If only one cleaning time is to be programmed, cleaning times 1 and 2 must be identical.
      - “**Display contrast**”: You can set the contrast of the display.
      - “**Display brightness**”: You can set the brightness of the display.
      - “**Display brightness (standby)**”: You can set the brightness of the display in standby mode.
      - “**Lighting output**”: You can set the brightness of the lighting output.
      - “**Front light colour**”: You can set the colour of the front lighting.
      - “**Change style**”: You can select the visual style of the display from various templates.

## c) Event display

- (9) Select the “**Process**” symbol to display important events or error messages for the machine.

## d) Exiting the Manager menu

- (10) Exit the Manager menu by touching “**Logout**”.

## 11. Cleaning

Clean the coffee machine carefully in compliance with the following instructions to maintain the value and hygiene of the unit.

### 11.1 Cleaning intervals

- **Daily** cleaning of all systems (brewing, milk and instant system), which have been used at least once, and emptying the grounds drawer is mandatory.
- If the coffee machine or a system **has not been used longer than 7 days**, cleaning must be performed before the machine is taken into operation again.
- Housing parts and strainer in the fresh water supply (if present) must be cleaned on a **monthly** basis.
- **Before switching off**, we recommend that you clean all the systems you have used.

#### a) Cleaning request

This flashes on the display, if ...

- one of the cleaning intervals programmed under 10.6 b) has been **exceeded** ...
- **and** the machine has been operating for at least 1 hour since the last cleaning cycle ...
- **and** at least 1 product has been dispensed.

During the cleaning request the products partly remain visible in the background and can still be dispensed for a short period of time.

#### b) Automatic dispensing lock

The products are no longer displayed and dispensing is **blocked** until the next cleaning, if ...

- **more than 50 products** have been dispensed **or more than 3 hours** have passed since the appearance of the cleaning request,
- or if more **than one week has passed** since the **last cleaning** of the system.
- The **corresponding systems must first be cleaned**, before the cleaning request or dispensing lock can be **reset**.

### 11.2 Cleaning agents

- Use only cleaning solutions mentioned in the instruction manual, because these have been optimally matched to the automatic cleaning program:
- Melitta® Cafina® Combi tablets
- Melitta® Cafina® AMC

### Caution when using cleaning agents!

- ⚠ Cleaning agents may be a health hazard when swallowed, inhaled and in contact with skin. Make sure that ...
- Do not feed or insert cleaning solutions into containers other than the ones described in these instructions,
- any information on cleaning agents must be easily accessible also in emergency situations. If you are using the agents recommended by Melitta this information is enclosed with each of the solutions.
- Keep cleaning solutions out of the reach of children.
- Wear suitable protective gloves.
- Follow the warning notes on the cleaning solutions containers.

### 11.3 If you are working with canisters

- **Empty** both canisters daily! Do not leave any residual water in them; fresh water can quickly contaminate with mould spores.
- Also observe the **water carbonate hardness** limit values with canister operation! The freshwater canister may need to be filled through the water filter (Brita).
- **Clean** the fresh water container and its lid area with a conventional dish washing agent and thoroughly rinse off any cleaner residues before each filling.
- Also clean the **waste water container** daily with dish washing agent to avoid the development of odours caused by organic residues in the waste water.
- Clean also the **strainer** in the fresh water hose – this is necessary with every machine maintenance, but at least once every year. For this purpose unscrew the front cap and rinse out the strainer.
- Ensure that the fresh water container is filled with **enough water** and that the waste water container is empty before you begin the cleaning programme.

## Warning!

When performing the cleaning activities, **make sure that the machine ...**

- is **never** subjected to pouring water and
- it is **never** spray clean with a hose.
- Also, **do not spray clean the installation area**, e.g. with a water hose or high-pressure cleaner.
- ⚠ Danger to life from electrical shock may otherwise occur from water entering the unit and touching live parts.
- ⚠ **Risk of scalding!** Do not reach into the dispensing area during automatic cleaning.
- First pull out the power plug and allow the machine to cool down before performing cleaning work on the machine by hand.
- ⚠ You thereby prevent the risk of injury from accidentally touching hot or moving parts during cleaning.

### 11.4 Daily cleaning

It is not possible to dispense products during cleaning. Product dispensing can only be continued once all containers have been reinserted.

#### a) Cleaning the grounds drawer

If the grounds are not discharged into the optional container, but into the grounds drawer:

- Open the **grounds drawer door** and pull out the drawer located behind it as illustrated under 8.5. Empty it into the regular domestic refuse.

Remove loose dirt, also from inside the **slot** of the grounds drawer. You may otherwise not be able to insert it properly and a malfunction may occur.

- In case of persistent dirt the grounds drawer can be cleaned in a **dish washer**.

If the grounds drawer has been removed or has not been correctly inserted, the display will show a corresponding message. If this was the case for longer than 3 seconds, you will be asked whether the **grounds drawer is empty**:

- Press the **"Yes"** button if the grounds drawer has been emptied.

#### b) Start the cleaning programme

The machine's cleaning programme runs largely automatically.

- (1) Replace the **milk container** with an empty **cleaning container**.

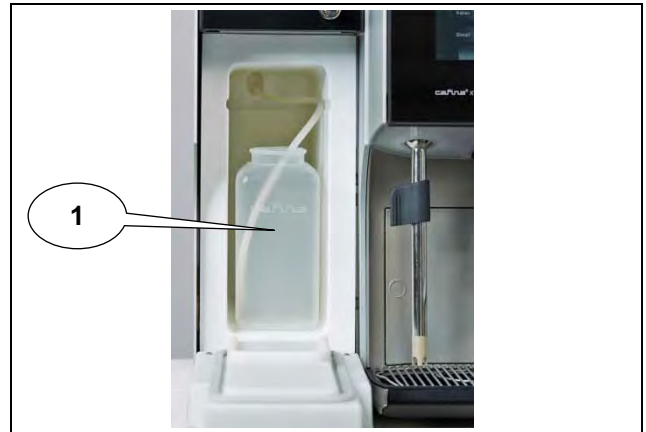

- Wipe the outside of the **milk hose**, which protrudes from the machine, with a damp cloth.
- Clean the **interior** of the refrigerator (if present) as well as the **door** and the **door seals** with a conventional domestic cleaning agent.
  - Leave the **door open** during the whole cleaning process. Otherwise, condensation will build up which can lead to an adverse effect on the function.

- (2) Touch the **"Unit"** button on the display and then ...
  - **"Clean and switch off full system"** if you wish to have the milk and brewing system cleaned and then switch the machine off.
  - **"Clean full system"** if you wish to have the milk and brewing system cleaned and then continue to operate the machine.



If you are prompted to first clean the instant system, carry this out (see 11.5) and then confirm that the system has been fully reassembled by touching “Instant system has been cleaned” and then “Instant system mounted”.

As soon as “Milk system cleaning agent” appears on the display ...

- (3) place a **cleaning tablet** in the prepared **cleaning container** and ...



- confirm that you have inserted the cleaning tablet by touching “Cleaning agent has been added” on the display.

As soon as “Brewing system cleaning agent” appears on the display ...

- (4) **open** the **unit door** with the supplied key and ...



- (5) **remove** the **tablet retainer** by turning it a quarter of a turn **anti-clockwise**.

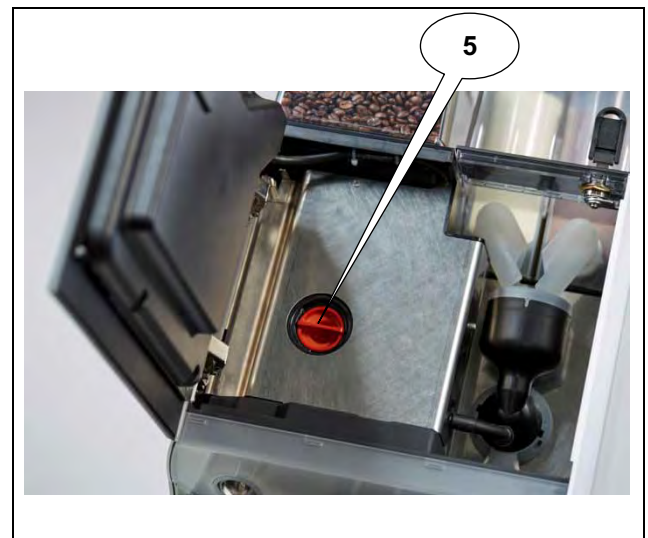

- (6) Place a **cleaning tablet** in the tablet retainer and ...

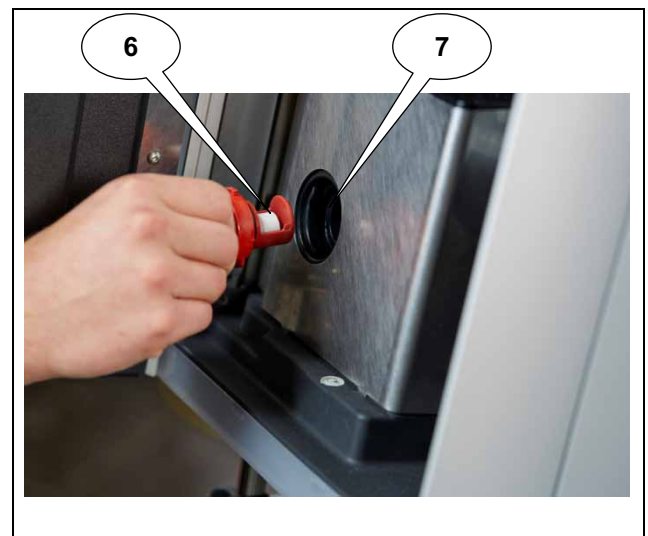

- (7) **turn** the tablet retainer a quarter of a turn clockwise so that it is tight again in the machine and **close** the unit door.
  - Confirm that you have inserted the cleaning tablet by touching “Cleaning agent has been inserted” on the display.

The machine only starts the automatic cleaning programme once both cleaning tablets have been inserted.

As soon as the automatic cleaning programme is complete, clean the **dispensing area** as described under 11.9.

Once cleaning has been completed, the machine switches itself off again or returns to standby for dispensing – depending on the selection.

- If you wish to continue to operate the machine, place a container of **milk** in a fridge (e.g. the XT6 MC18 fridge, which is available as an option) and insert the **milk suction tube** in the milk container.

**Note:** Replace the cleaning tablet once a week with AMC powder in order to prevent premature blocking. This provides acidic cleaning of the milk component.

### 11.5 Cleaning the instant system

**Daily cleaning** is required when the instant system is used.

- Open the machine door with the key.

#### a) Disassembling the mixer unit

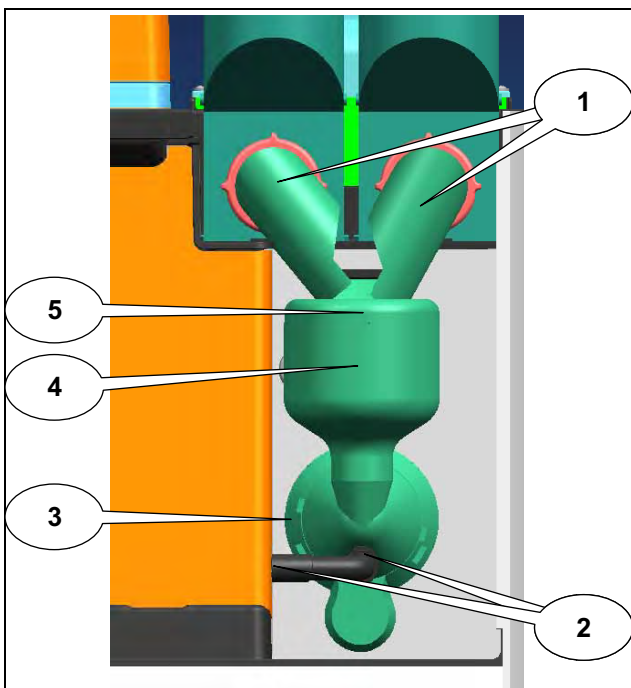

- (1) Move the **powder chutes** forwards.
  - Remove the **instant coffee container** by lifting it up and out.
- (2) Pull off the **instant beverage hose**, from the mixer housing and the beverage spout.
- (3) Turn the **mixer flange** anti-clockwise until the arrow is pointing to the “open lock” symbol.
- (4) Now you can pull the **complete mixer housing** forward and out.
- (5) Remove the cover of the mixer housing.
- (6) Remove the **mixer impeller** from the axle using the supplied extraction tool.

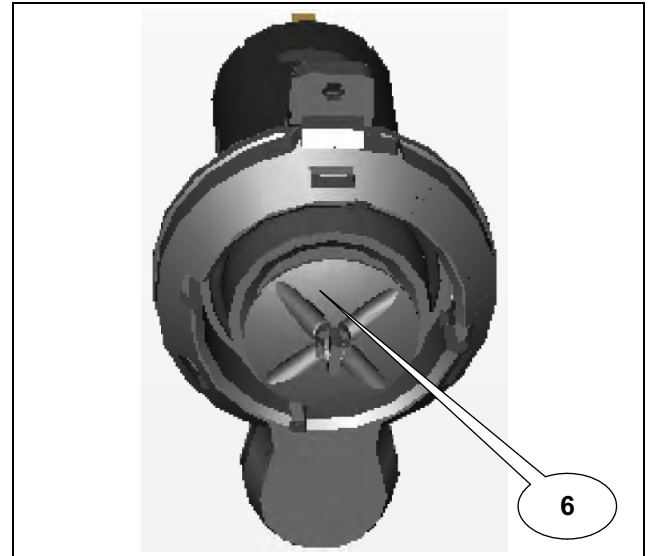

#### b) Cleaning the mixer unit

- Thoroughly clean all parts with hot water and a **milk product compatible cleaning agent** – or in the dish washer. Subsequently rinse all parts with clear water.
- Completely dry all parts to avoid agglutination of instant powder.
- Clean the area around the axis with a damp cloth. This is where you removed the mixer impeller.
- Also clean the mixer chamber carefully.

#### c) Assembling the mixer unit

Now you can reassemble all parts in reverse order. Please take care:

- (6) Place the **mixer impeller** on the axle so that its **tapered side** lines up with the **marking** (arrow on the mixer impeller).

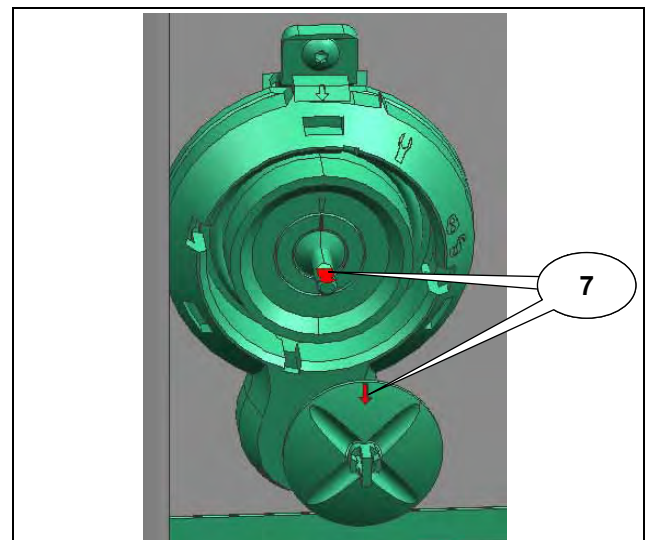

- (5) Replace the **cover of the mixer housing**.
- (4) Insert the **mixer housing**.
- (3) Turn the **mixer flange** clockwise (the arrow points to the “**closed lock**” symbol) to tighten it.
- (2) Push the **instant drink hose** fully on to the connections on the mixer unit and the nozzle.
- (1) Plug on the **powder chutes**. Do **not reach with your fingers** into the previously cleaned powder chutes!
  - Ensure that the powder chutes are pointing into the mixer container.

### 11.6 Cleaning the coffee bean containers

**Switch off** the machine as described under 8.3 and allow it to **cool down**.

- Open the cover of the **coffee bean container**.
- (8) Turn the **lever anti-clockwise** to **release** the coffee bean containers and remove the containers.
  - **Clean** the bean container in hot water with a regular dish washing liquid or in the dish washer.
- **Dry** all parts completely and reassemble them.
- (8) Turn the **lever clockwise** to **lock** the coffee bean containers back into place and attach the cover.

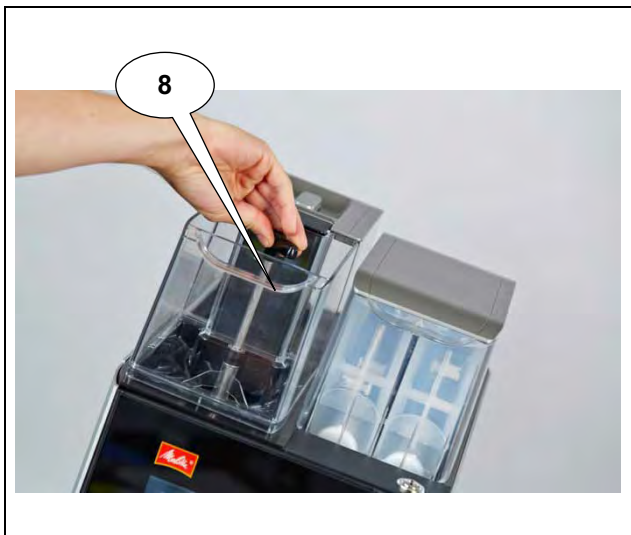

**Note:** The lids of the bean containers can only be put back into place, if the bean containers are properly locked.

### 11.7 Cleaning the instant coffee containers

- Open the cover of the instant coffee containers as described under 8.1 b) and ...
- remove the inner **transparent instant coffee container** by lifting it up and out.
  - **Clean** these parts in hot water with regular dish washing liquid or in the dish washer.

**Dry** all parts completely and reassemble them.

### 11.8 Clean touch screen

This is necessary in case of visible contamination.

- Select “**Unit**” in Waiter operation and then ...
  - “**Clean touchscreen**” to lock the display against input.
- **Clean** the touchscreen with the microfibre cloth provided or an appropriate damp cloth. Ensure the touchscreen is completely dried and streak free if a damp cloth has been used.

After cleaning unlock the display by successively touching the **numbers 1 – 4** in the corners of the display.

### 11.9 Cleaning the dispensing area

Wipe plastic parts, painted surfaces and stainless steel parts regularly with a wet cloth. Do not use any abrasive agents or sharp objects.



- (9) Remove the **drip grill** as soon as soiling is visible.

- (10) Then wipe out the **drip tray** with a damp cloth.

## 12. Preventive maintenance

- ⚠ Due to the associated dangers, repairs and preventive maintenance activities must only be performed by customer service or professionals authorized by the manufacturer for this purpose.

### 12.1 Intervals

Always after 30.000 cups or 12 months of operation (whichever occurs first), a major **maintenance of the machine** must be carried out by the customer service (chargeable service).

- Take care to make such an appointment early on to avoid unnecessary wear.
- Monitor your upstream **water filters** for effectiveness, as described in their documents.
- Replace all water filters no later than every 12 months to prevent germ formation and water contamination.

Upon request, customer service will offer a comprehensive maintenance contract which also ensures the observation of all inspection and service intervals.

The **inspection** – legally required for commercial operators – of the system every 4 years by an authorized electrician for proper condition must be performed and documented. This can be done and certified by the customer service (no additional inspection is required before the initial commissioning).

### 12.2 In case of defects

- ⚠ First have **malfunctions or damages** inspected and, if necessary repaired, by the customer service before you continue using the machine.
- ⚠ **In all of these cases, pull the plug out** of the socket and turn off the water.

## 13. Disposal

The machine has been designed and manufactured to facilitate environmentally friendly disposal.

### a) Waste disposal

The waste generated by brewing is purely organic and may therefore be disposed off with the regular domestic refuse.

### b) Waste water disposal

The waste water generated by brewing and cleaning corresponds to the properties of general domestic waste water and therefore may be discharged through the normal sewer system.

### c) Disposal of cleaning agents

The cleaning agents recommended in these instructions comply with the legal stipulations if used as instructed and may therefore be discharged with the waste water through the normal sewer system without additional measures.

### d) Disposal of the machine

This coffee machine contains valuable raw materials which should be directed to **recycling**.



**Do not dispose off the machine through the domestic waste!**

Make sure to follow the applicable national and regional legislation and guidelines regarding disposal.

**SERVICE-Scheckheft**  
**SERVICE Confirmations**

Wartungsvertrag abgeschlossen  
*Service contract existing*

ja / yes  nein / no

Maschinen Nr. / *machine-no.:* \_\_\_\_\_

1. Inspektion / Wartung  
*1th Service / Maintenance*

Datum der Erstinstantion / *date of first installation* \_\_\_\_\_

am: \_\_\_\_\_  
*Date*

\_\_\_\_\_  
*Unterschrift und Stempel Kundendienst*  
*Signature and stamp Service Technician*

**INSPEKTION / WARTUNG**  
**MAINTENANCE**

Arbeiten durchgeführt bei:  
*SERVICE been effected*

Nächste Inspektion / Wartung bei:  
*Next Service / Maintenance*

- Arbeiten gemäß Checkliste ausgeführt*  
*works been carried out according to check list*
- Wasserfilter ersetzt  
*Waterfilter been replaced*
- Verschleißteile ersetzt  
*wearing parts been replaced*
- Maschine eingestellt und Funktion überprüft  
*machine been adjusted and function been checked*

Datum: \_\_\_\_\_  
*Date*

Datum: \_\_\_\_\_  
*Date*

Name: \_\_\_\_\_  
*Name*

Sonstige Arbeiten: \_\_\_\_\_  
*other works*

**INSPEKTION / WARTUNG**  
**MAINTENANCE**

Arbeiten durchgeführt bei:  
*SERVICE been effected*

Nächste Inspektion / Wartung bei:  
*Next Service / Maintenance*

- Arbeiten gemäß Checkliste ausgeführt*  
*works been carried out according to check list*
- Wasserfilter ersetzt  
*Waterfilter been replaced*
- Verschleißteile ersetzt  
*wearing parts been replaced*
- Maschine eingestellt und Funktion überprüft  
*machine been adjusted and function been checked*

Datum: \_\_\_\_\_  
*Date*

Datum: \_\_\_\_\_  
*Date*

Name: \_\_\_\_\_  
*Name*

Sonstige Arbeiten: \_\_\_\_\_  
*other works*

**INSPEKTION / WARTUNG**  
**MAINTENANCE**

Arbeiten durchgeführt bei:  
*SERVICE been effected*

Nächste Inspektion / Wartung bei:  
*Next Service / Maintenance*

- Arbeiten gemäß Checkliste ausgeführt*  
*works been carried out according to check list*
- Wasserfilter ersetzt  
*Waterfilter been replaced*
- Verschleißteile ersetzt  
*wearing parts been replaced*
- Maschine eingestellt und Funktion überprüft  
*machine been adjusted and function been checked*

Datum: \_\_\_\_\_  
*Date*

Datum: \_\_\_\_\_  
*Date*

Name: \_\_\_\_\_  
*Name*

Sonstige Arbeiten: \_\_\_\_\_  
*other works*

**INSPEKTION / WARTUNG**  
**MAINTENANCE**

Arbeiten durchgeführt bei:  
*SERVICE been effected*

Nächste Inspektion / Wartung bei:  
*Next Service / Maintenance*

- Arbeiten gemäß Checkliste ausgeführt*  
*works been carried out according to check list*
- Wasserfilter ersetzt  
*Waterfilter been replaced*
- Verschleißteile ersetzt  
*wearing parts been replaced*
- Maschine eingestellt und Funktion überprüft  
*machine been adjusted and function been checked*

Datum: \_\_\_\_\_  
*Date*

Datum: \_\_\_\_\_  
*Date*

Name: \_\_\_\_\_  
*Name*

Sonstige Arbeiten: \_\_\_\_\_  
*other works*



**SERVICE-Scheckheft**  
**SERVICE Confirmations**

Wartungsvertrag abgeschlossen  
*Service contract existing*

ja / yes  nein / no

Maschinen Nr. / *machine-no.:* \_\_\_\_\_

1. Inspektion / Wartung  
*1th Service / Maintenance*

Datum der Erstinbetriebnahme / *date of first installation* \_\_\_\_\_

am: \_\_\_\_\_  
*Date*

\_\_\_\_\_  
*Unterschrift und Stempel Kundendienst*  
*Signature and stamp Service Technician*

**INSPEKTION / WARTUNG**  
**MAINTENANCE**

Arbeiten durchgeführt bei:  
*SERVICE been effected*

Nächste Inspektion / Wartung bei:  
*Next Service / Maintenance*

- Arbeiten gemäß Checkliste ausgeführt*  
*works been carried out according to check list*
- Wasserfilter ersetzt  
*Waterfilter been replaced*
- Verschleißteile ersetzt  
*wearing parts been replaced*
- Maschine eingestellt und Funktion überprüft  
*machine been adjusted and function been checked*

Datum: \_\_\_\_\_  
*Date*

Datum: \_\_\_\_\_  
*Date*

Name: \_\_\_\_\_  
*Name*

Sonstige Arbeiten: \_\_\_\_\_  
*other works*

**INSPEKTION / WARTUNG**  
**MAINTENANCE**

Arbeiten durchgeführt bei:  
*SERVICE been effected*

Nächste Inspektion / Wartung bei:  
*Next Service / Maintenance*

- Arbeiten gemäß Checkliste ausgeführt*  
*works been carried out according to check list*
- Wasserfilter ersetzt  
*Waterfilter been replaced*
- Verschleißteile ersetzt  
*wearing parts been replaced*
- Maschine eingestellt und Funktion überprüft  
*machine been adjusted and function been checked*

Datum: \_\_\_\_\_  
*Date*

Datum: \_\_\_\_\_  
*Date*

Name: \_\_\_\_\_  
*Name*

Sonstige Arbeiten: \_\_\_\_\_  
*other works*

**INSPEKTION / WARTUNG**  
**MAINTENANCE**

Arbeiten durchgeführt bei:  
*SERVICE been effected*

Nächste Inspektion / Wartung bei:  
*Next Service / Maintenance*

- Arbeiten gemäß Checkliste ausgeführt*  
*works been carried out according to check list*
- Wasserfilter ersetzt  
*Waterfilter been replaced*
- Verschleißteile ersetzt  
*wearing parts been replaced*
- Maschine eingestellt und Funktion überprüft  
*machine been adjusted and function been checked*

Datum: \_\_\_\_\_  
*Date*

Datum: \_\_\_\_\_  
*Date*

Name: \_\_\_\_\_  
*Name*

Sonstige Arbeiten: \_\_\_\_\_  
*other works*

**INSPEKTION / WARTUNG**  
**MAINTENANCE**

Arbeiten durchgeführt bei:  
*SERVICE been effected*

Nächste Inspektion / Wartung bei:  
*Next Service / Maintenance*

- Arbeiten gemäß Checkliste ausgeführt*  
*works been carried out according to check list*
- Wasserfilter ersetzt  
*Waterfilter been replaced*
- Verschleißteile ersetzt  
*wearing parts been replaced*
- Maschine eingestellt und Funktion überprüft  
*machine been adjusted and function been checked*

Datum: \_\_\_\_\_  
*Date*

Datum: \_\_\_\_\_  
*Date*

Name: \_\_\_\_\_  
*Name*

Sonstige Arbeiten: \_\_\_\_\_  
*other works*

**SERVICE-Scheckheft**  
**SERVICE Confirmations**

Wartungsvertrag abgeschlossen  
*Service contract existing*

ja / yes  nein / no

Maschinen Nr. / *machine-no.:* \_\_\_\_\_

1. Inspektion / Wartung  
*1th Service / Maintenance*

Datum der Erstinbetriebnahme / *date of first installation* \_\_\_\_\_

am: \_\_\_\_\_  
*Date*

\_\_\_\_\_  
*Unterschrift und Stempel Kundendienst*  
*Signature and stamp Service Technician*

**INSPEKTION / WARTUNG**  
**MAINTENANCE**

Arbeiten durchgeführt bei:  
*SERVICE been effected*

Nächste Inspektion / Wartung bei:  
*Next Service / Maintenance*

- Arbeiten gemäß Checkliste ausgeführt*  
*works been carried out according to check list*
- Wasserfilter ersetzt  
*Waterfilter been replaced*
- Verschleißteile ersetzt  
*wearing parts been replaced*
- Maschine eingestellt und Funktion überprüft  
*machine been adjusted and function been checked*

Datum: \_\_\_\_\_  
*Date*

Datum: \_\_\_\_\_  
*Date*

Name: \_\_\_\_\_  
*Name*

Sonstige Arbeiten: \_\_\_\_\_  
*other works*

**INSPEKTION / WARTUNG**  
**MAINTENANCE**

Arbeiten durchgeführt bei:  
*SERVICE been effected*

Nächste Inspektion / Wartung bei:  
*Next Service / Maintenance*

- Arbeiten gemäß Checkliste ausgeführt*  
*works been carried out according to check list*
- Wasserfilter ersetzt  
*Waterfilter been replaced*
- Verschleißteile ersetzt  
*wearing parts been replaced*
- Maschine eingestellt und Funktion überprüft  
*machine been adjusted and function been checked*

Datum: \_\_\_\_\_  
*Date*

Datum: \_\_\_\_\_  
*Date*

Name: \_\_\_\_\_  
*Name*

Sonstige Arbeiten: \_\_\_\_\_  
*other works*

**INSPEKTION / WARTUNG**  
**MAINTENANCE**

Arbeiten durchgeführt bei:  
*SERVICE been effected*

Nächste Inspektion / Wartung bei:  
*Next Service / Maintenance*

- Arbeiten gemäß Checkliste ausgeführt*  
*works been carried out according to check list*
- Wasserfilter ersetzt  
*Waterfilter been replaced*
- Verschleißteile ersetzt  
*wearing parts been replaced*
- Maschine eingestellt und Funktion überprüft  
*machine been adjusted and function been checked*

Datum: \_\_\_\_\_  
*Date*

Datum: \_\_\_\_\_  
*Date*

Name: \_\_\_\_\_  
*Name*

Sonstige Arbeiten: \_\_\_\_\_  
*other works*

**INSPEKTION / WARTUNG**  
**MAINTENANCE**

Arbeiten durchgeführt bei:  
*SERVICE been effected*

Nächste Inspektion / Wartung bei:  
*Next Service / Maintenance*

- Arbeiten gemäß Checkliste ausgeführt*  
*works been carried out according to check list*
- Wasserfilter ersetzt  
*Waterfilter been replaced*
- Verschleißteile ersetzt  
*wearing parts been replaced*
- Maschine eingestellt und Funktion überprüft  
*machine been adjusted and function been checked*

Datum: \_\_\_\_\_  
*Date*

Datum: \_\_\_\_\_  
*Date*

Name: \_\_\_\_\_  
*Name*

Sonstige Arbeiten: \_\_\_\_\_  
*other works*

**SERVICE-Scheckheft**  
**SERVICE Confirmations**

Wartungsvertrag abgeschlossen  
*Service contract existing*

ja / yes  nein / no

Maschinen Nr. / *machine-no.:* \_\_\_\_\_

1. Inspektion / Wartung  
*1th Service / Maintenance*

Datum der Erstinbetriebnahme / *date of first installation* \_\_\_\_\_

am: \_\_\_\_\_  
*Date*

\_\_\_\_\_  
*Unterschrift und Stempel Kundendienst*  
*Signature and stamp Service Technician*

**INSPEKTION / WARTUNG**  
**MAINTENANCE**

Arbeiten durchgeführt bei:  
*SERVICE been effected*

Nächste Inspektion / Wartung bei:  
*Next Service / Maintenance*

- Arbeiten gemäß Checkliste ausgeführt*  
*works been carried out according to check list*
- Wasserfilter ersetzt  
*Waterfilter been replaced*
- Verschleißteile ersetzt  
*wearing parts been replaced*
- Maschine eingestellt und Funktion überprüft  
*machine been adjusted and function been checked*

Datum: \_\_\_\_\_  
*Date*

Datum: \_\_\_\_\_  
*Date*

Name: \_\_\_\_\_  
*Name*

Sonstige Arbeiten: \_\_\_\_\_  
*other works*

**INSPEKTION / WARTUNG**  
**MAINTENANCE**

Arbeiten durchgeführt bei:  
*SERVICE been effected*

Nächste Inspektion / Wartung bei:  
*Next Service / Maintenance*

- Arbeiten gemäß Checkliste ausgeführt*  
*works been carried out according to check list*
- Wasserfilter ersetzt  
*Waterfilter been replaced*
- Verschleißteile ersetzt  
*wearing parts been replaced*
- Maschine eingestellt und Funktion überprüft  
*machine been adjusted and function been checked*

Datum: \_\_\_\_\_  
*Date*

Datum: \_\_\_\_\_  
*Date*

Name: \_\_\_\_\_  
*Name*

Sonstige Arbeiten: \_\_\_\_\_  
*other works*

**INSPEKTION / WARTUNG**  
**MAINTENANCE**

Arbeiten durchgeführt bei:  
*SERVICE been effected*

Nächste Inspektion / Wartung bei:  
*Next Service / Maintenance*

- Arbeiten gemäß Checkliste ausgeführt*  
*works been carried out according to check list*
- Wasserfilter ersetzt  
*Waterfilter been replaced*
- Verschleißteile ersetzt  
*wearing parts been replaced*
- Maschine eingestellt und Funktion überprüft  
*machine been adjusted and function been checked*

Datum: \_\_\_\_\_  
*Date*

Datum: \_\_\_\_\_  
*Date*

Name: \_\_\_\_\_  
*Name*

Sonstige Arbeiten: \_\_\_\_\_  
*other works*

**INSPEKTION / WARTUNG**  
**MAINTENANCE**

Arbeiten durchgeführt bei:  
*SERVICE been effected*

Nächste Inspektion / Wartung bei:  
*Next Service / Maintenance*

- Arbeiten gemäß Checkliste ausgeführt*  
*works been carried out according to check list*
- Wasserfilter ersetzt  
*Waterfilter been replaced*
- Verschleißteile ersetzt  
*wearing parts been replaced*
- Maschine eingestellt und Funktion überprüft  
*machine been adjusted and function been checked*

Datum: \_\_\_\_\_  
*Date*

Datum: \_\_\_\_\_  
*Date*

Name: \_\_\_\_\_  
*Name*

Sonstige Arbeiten: \_\_\_\_\_  
*other works*

**Melitta macht Kaffee zum Genuss®**

