

# 700

## Snack 700



## Characteristics



### A Refrigeration unit

Sparblock plug-in - monobloc ventilated system

### B Evaporator

Treated by cataphoresis, 316L stainless steel coil

### C Controllore

Capacitive touch screen

### D Door

Thickness 60mm, reversible right/left opening, self-closing 110° opening, removable double chamber magnetic gasket

### E Insulation thickness

60mm - HFO polyurethane (no CFC, no HCFC)

### F Internal finish

AISI 304 stainless steel

### J Floor support

Stainless steel feet, galvanised external bottom panel

### K Rounded corners/removable parts

For easy cleaning

### O Worktop

AISI 304

# Technical drawing and set-up

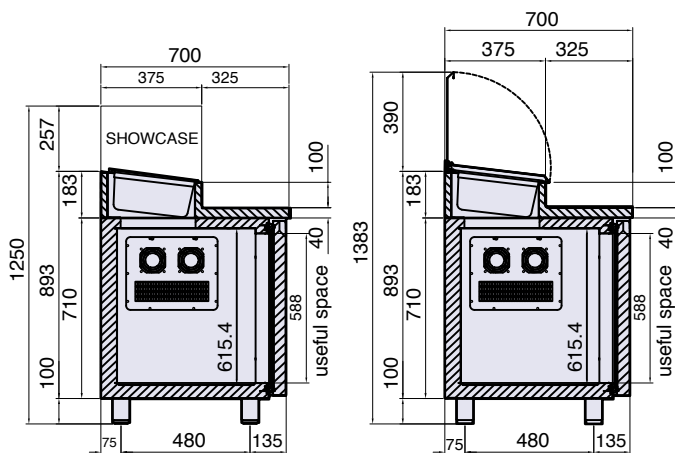
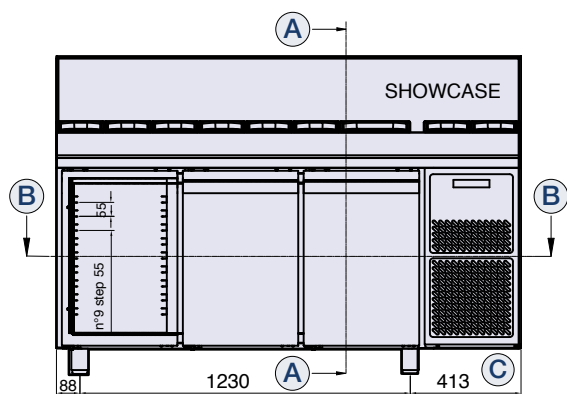

**A-A**

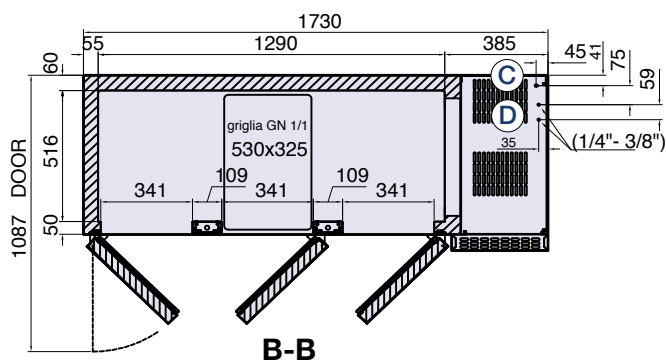

**B-B**

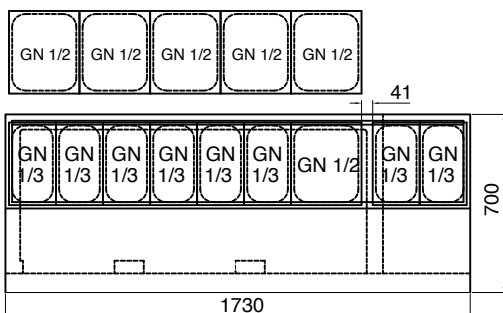

**A Section plane**

**B Section plane**

**C Power cable outlet (length 2 m)**







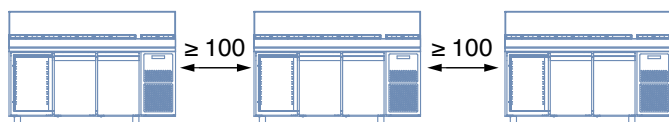

WARNING! While installing, have a qualified electrician connect it to an electrical panel.

**D Gas pipes outlet**

Prepared for remote motor



## Technical specifications

<b>Temperature (°C)</b>			
<b>Model</b>	<b>PPCS703CXX</b>	<b>PPCS703ANCXX</b>	<b>PPCS703CMRXX</b>
<b>Doors</b>			
<b>Dimensions (mm)</b> L x D x H	1730 x 700 x 1030-1080	1730 x 700 x 1030-1080	1730 x 700 x 1030-1080
<b>Packaging (mm)</b> L x D x H	1770 x 730 x 1120	1770 x 730 x 1120	1770 x 730 x 1120
<b>Refrigerant</b>			
<b>Absorption (W)</b>	318	350	30
<b>Voltage (V-Hz)</b>	AC 230V 1N+T (50Hz)/AC 230V 1N+T (60Hz)	AC 230V 1N+T (50Hz)/AC 230V 1N+T (60Hz)	AC 230V 1N+T (50Hz)/AC 230V 1N+T (60Hz)
<b>Net weight (kg)</b>	147	147	132
<b>Gross weight (kg)</b>	163	163	148
<b>Tray-grids included (n.)</b>	1 grids x door GN 1/1 530x325	1 grids x door GN 1/1 530x325	1 grids x door GN 1/1 530x325

## Standard equipment

- # 1 plastic-coated grille with door guides

