

700 Snack 700



Characteristics



A Refrigeration unit

Sparblock plug-in - monobloc ventilated system

B Evaporator

Treated by cathoporesis, 316L stainless steel coil

C Controllore

Capacitive touch screen

D Door

Thickness 60mm, reversible right/left opening, self-closing
110° opening, removable double chamber magnetic gasket

E Insulation thickness

60mm - HFO polyurethane (no CFC, no HCFC)

F Internal finish

AISI 304 stainless steel

J Floor support

Stainless steel feet, galvanised external bottom panel

K Rounded corners/removable parts

For easy cleaning

O Worktop

AISI 304

Technical drawing and set-up

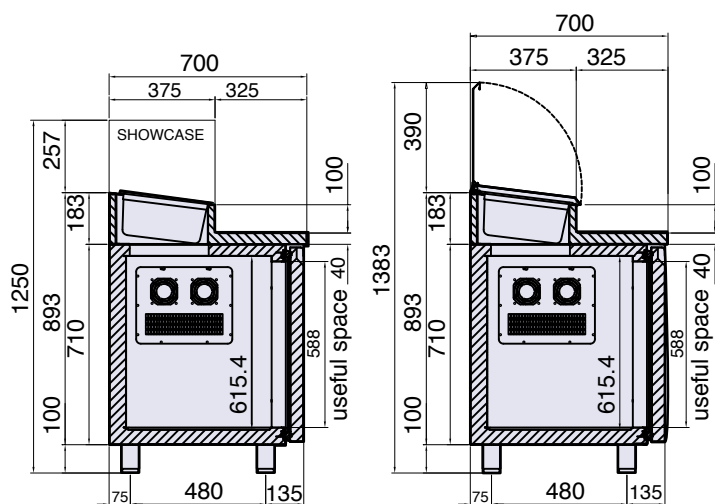
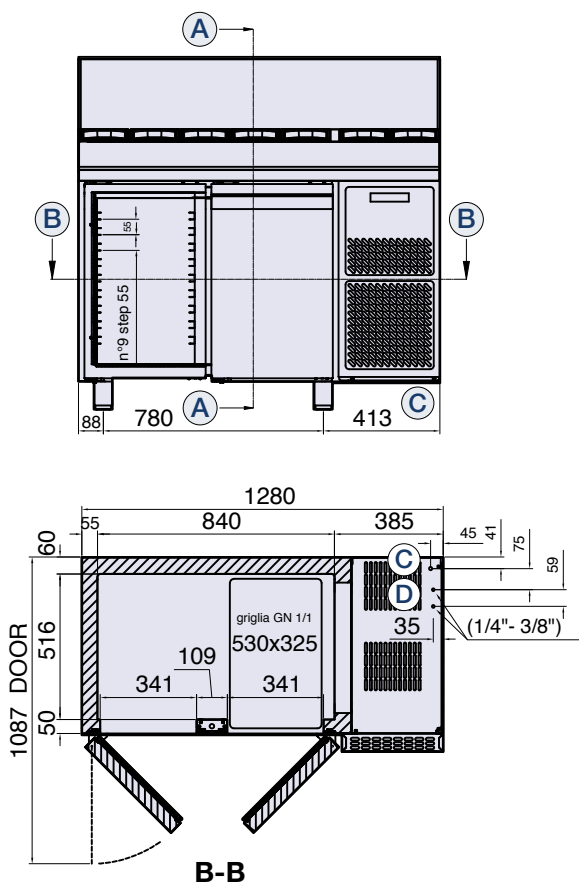

A-A

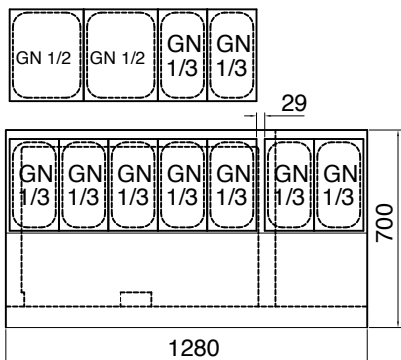

A Section plane

B Section plane

C Power cable outlet (length 2 m)







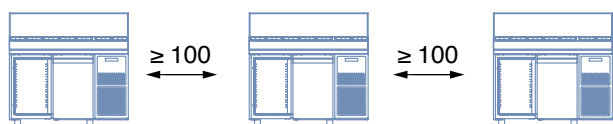

WARNING! While installing, have a qualified electrician connect it to an electrical panel.

D Gas pipes outlet

Prepared for remote motor



Technical specifications

Temperature (°C)			
Model	PPCS702CXX	PPCS702ANCXX	PPCS702CMRXX
Doors			
Dimensions (mm) L x D x H	1280 x 700 x 1030-1080	1280 x 700 x 1030-1080	1280 x 700 x 1030-1080
Packaging (mm) L x D x H	1320 x 730 x 1120	1320 x 730 x 1120	1320 x 730 x 1120
Refrigerant			
Absorption (W)	318	350	30
Voltage (V-Hz)	AC 230V 1N+T (50Hz)/AC 230V 1N+T (60Hz)	AC 230V 1N+T (50Hz)/AC 230V 1N+T (60Hz)	AC 230V 1N+T (50Hz)/AC 230V 1N+T (60Hz)
Net weight (kg)	118	118	103
Gross weight (kg)	131	131	116
Tray-grids included (n.)	1 grids x door GN 1/1 530x325	1 grids x door GN 1/1 530x325	1 grids x door GN 1/1 530x325

Standard equipment

- # 1 plastic-coated grille with door guides

